

Maru

Small (1100mm/43")

Large (1400mm/55")

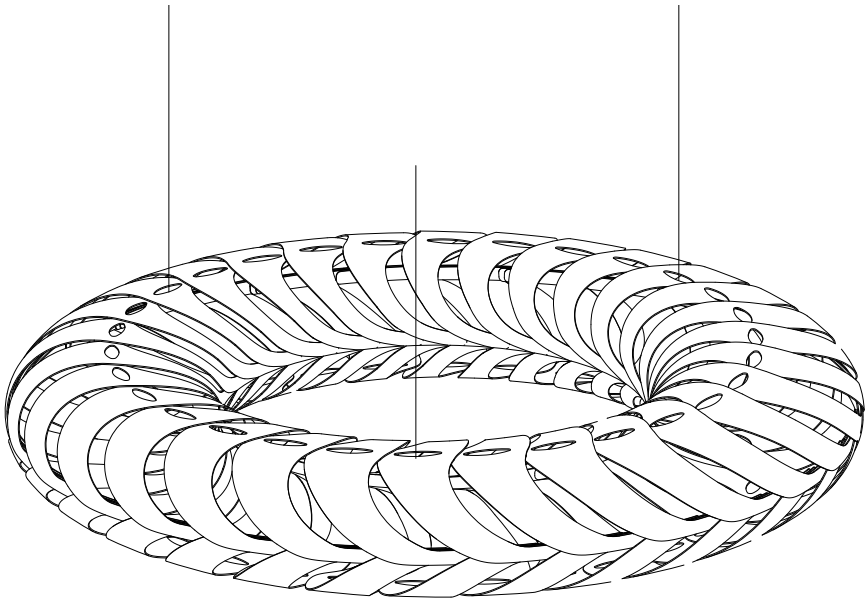

Assembly
time approx



minutes

Please check your components:

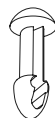
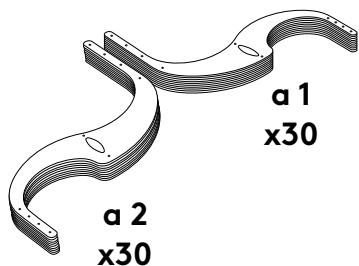

(60 + 2 spare)

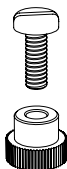
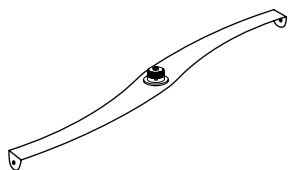

d
x3

e
x7

f
x3

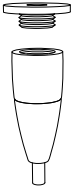

g
x3

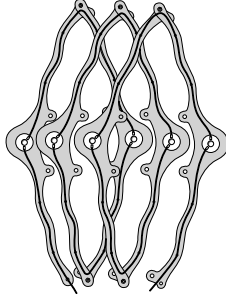

h
x1

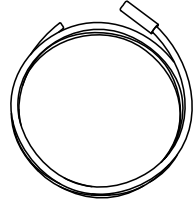

i
x1

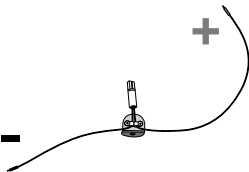

j
x1

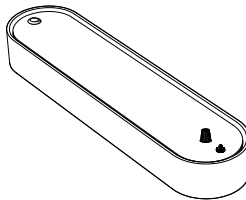

Canopy
x1

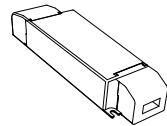

LED Driver
x1

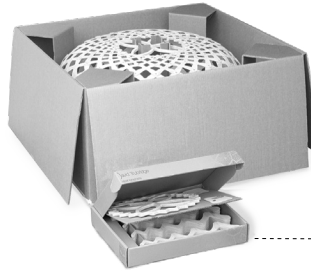

OLD SYSTEM

1 box = 1 assembled light

SEED SYSTEM

30 kitset boxes = 1 old box

EN Thank you for buying a Seed System kitset lightshade which is on average 1/30th of the volume of the assembled light. Seed System designs are only made possible through your involvement as you 'grow' your kitset into a lightshade. Together we have helped to minimize the effects of shipping, to reduce the number of trucks on the road and decrease the design's environmental footprint.

IT Grazie per aver acquistato il kit di assemblaggio di una lampada "Seed System", in media un 1/30del volume della medesima lampada già assemblata. Il design "Seed System" è possibile soltanto tramite la vostra collaborazione, in quanto sarete voi stessi a far diventare il vostro kit una lampada vera e propria. Insieme cercheremo di minimizzare l'effetto del trasporto, diminuendo il numero di automezzi sulla strada e l'impatto ambientale dei prodotti.

DK Tak fordi du har købt en 'Seed System' kitset lampe der fylder gennemsnitlig 1/30 del af den samlede lampe. Seed System designet er kun gjort muligt gennem dit engagement, da du selv skal færdiggøre dit kitset som en lampeskærm. På den måde har vi sammen været med til atminimere skibsfart samt vi reducerer antallet af lastbiler på vejene. Dermed mindskes det miljømæssige fodaftryk.

FR Nous vous remercions d'avoir acheté un luminaire "Seed System". Vendus en kit, nos luminaires représentent en moyenne 1/30ème de leur volume assemblé, vous avez donc contribué à protéger l'environnement en réduisant le nombre de camions de transport sur les routes.

DE Vielen Dank für den Kauf der Seed System Kitset Licht Schatten Leuchte . Das Kitset entspricht dem Verhältnis im Durchschnitt 1/30 des Volumens der zusammengebauten Leuchte/ Lampe. Seed System Designs sind nur durch Ihre Beteiligung möglich, da Sie Ihr Kitset in eine Leuchte mit Lichtschatten "verwandeln". Gemeinsam haben wir es geschafft die Folgen des weltweiten Frachtverkehrs zu minimieren, die Anzahl der LKWs auf den Straßen zu reduzieren und den ökologischen Fußabdruck zu verkleinern.

ES Gracias por la compra del sistema kitset "Seed" de la lámpara la cual tiene solamente de media 1/30o del volumen de la luz montada. Los diseños del sistema "Seed" sólo se han hecho posibles gracias a su participación de "transformar" su kitset en una sombra de luz. Juntos hemos ayudado a minimizar los efectos de envío, para reducir el número de camiones en la carretera y disminuir la huella ambiental.

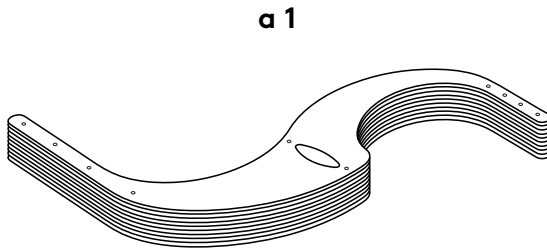
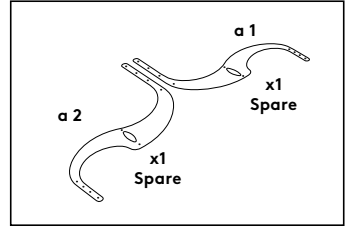
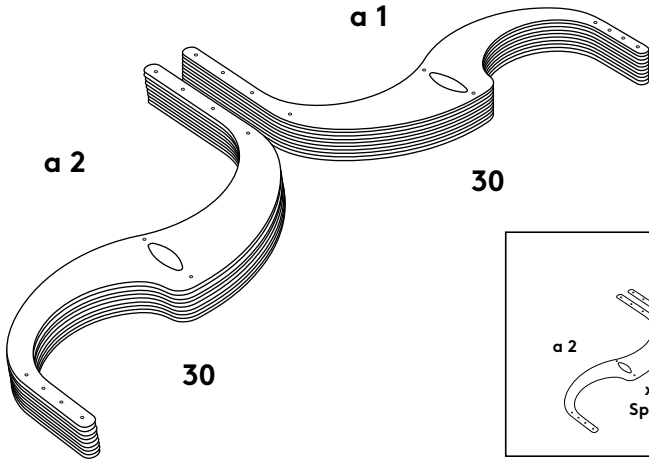

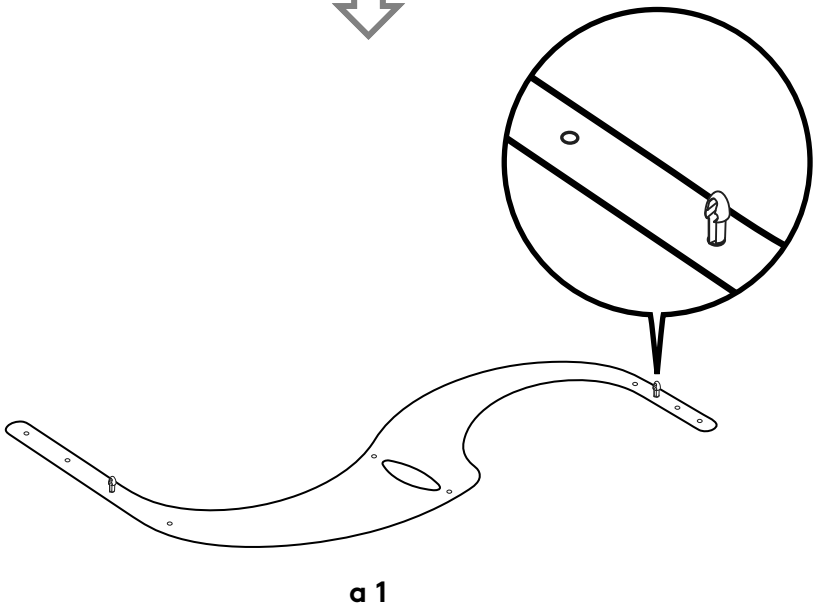
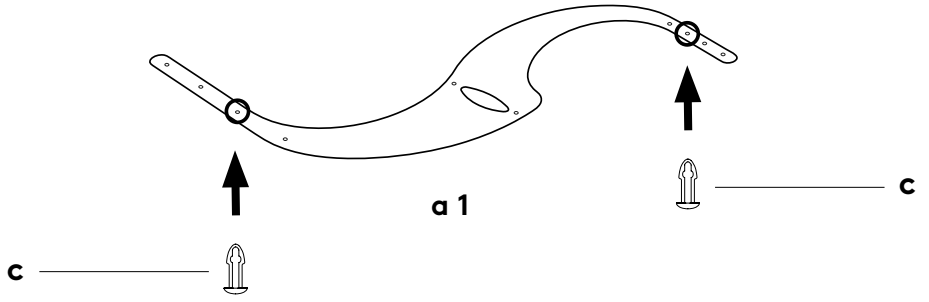

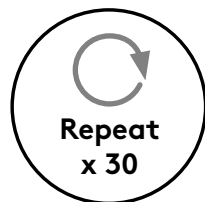
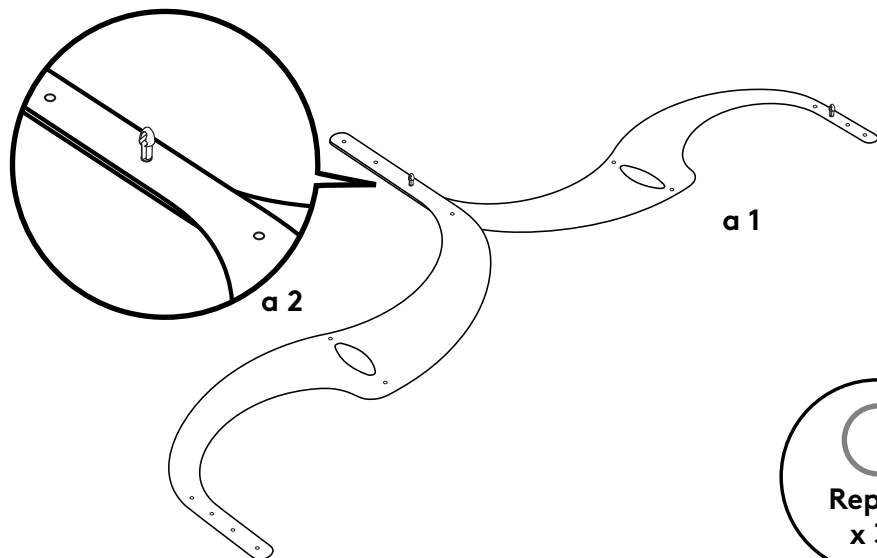
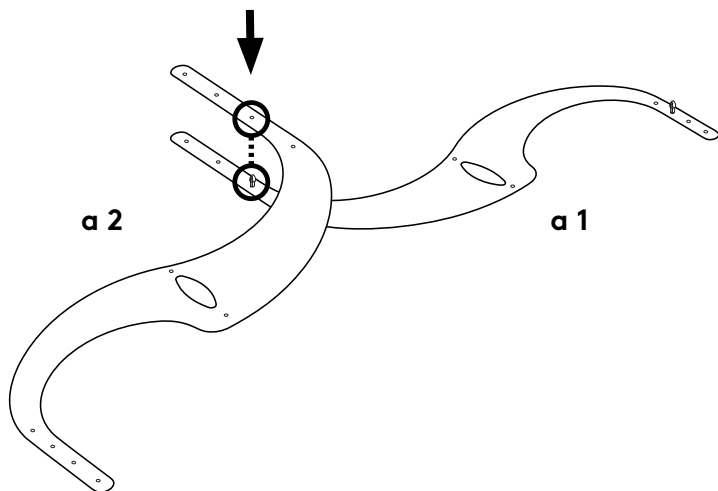

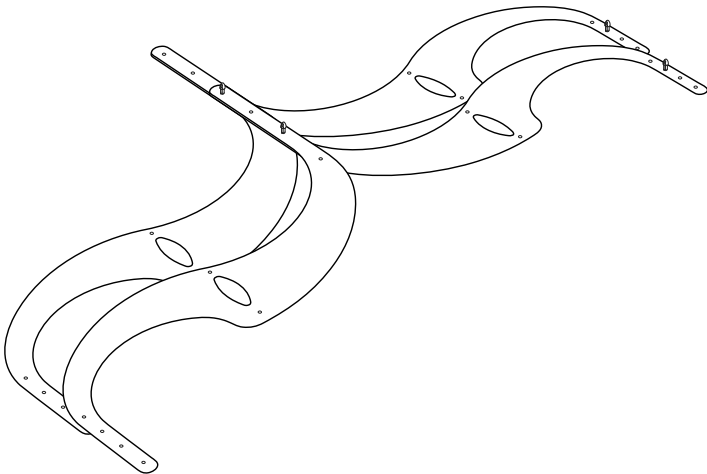
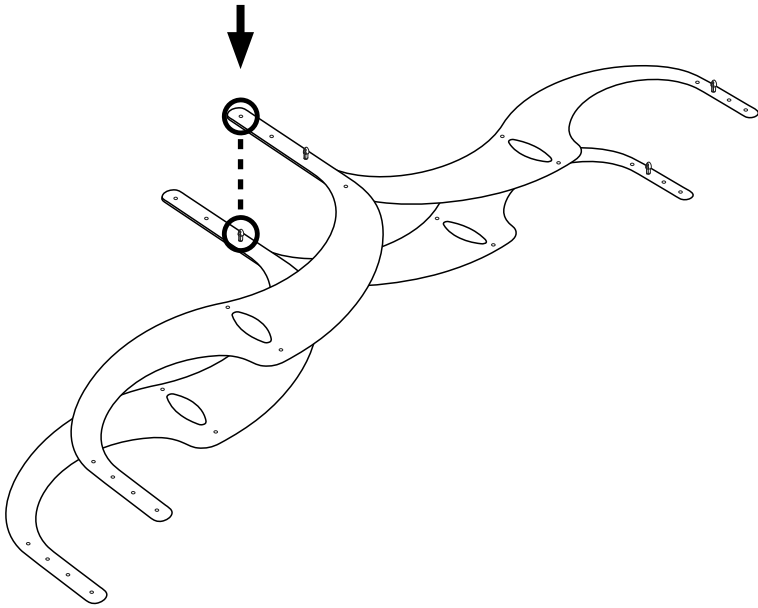

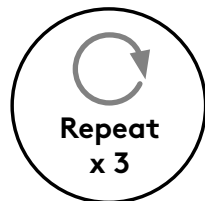
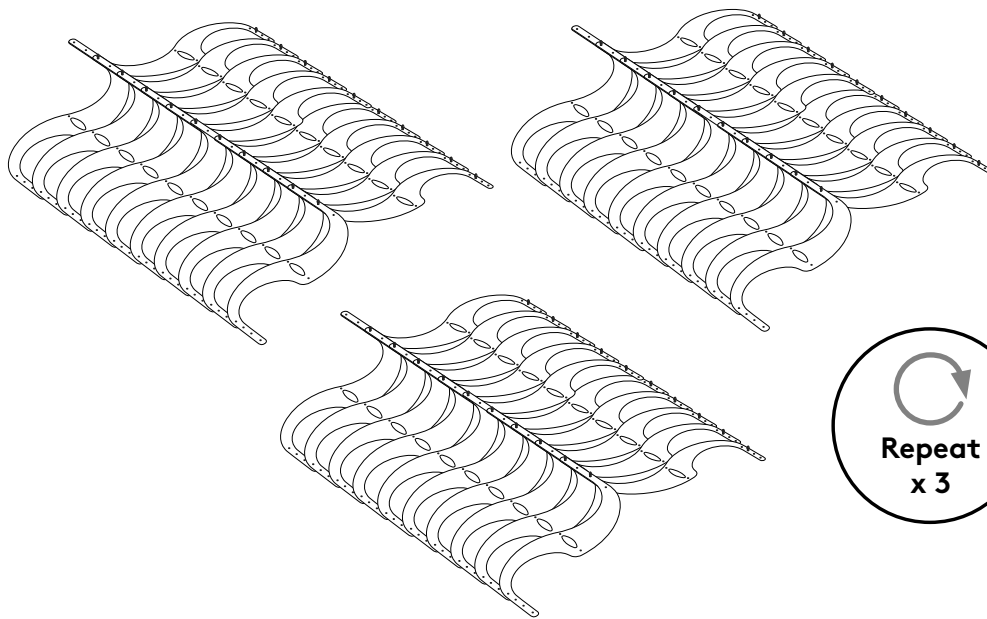
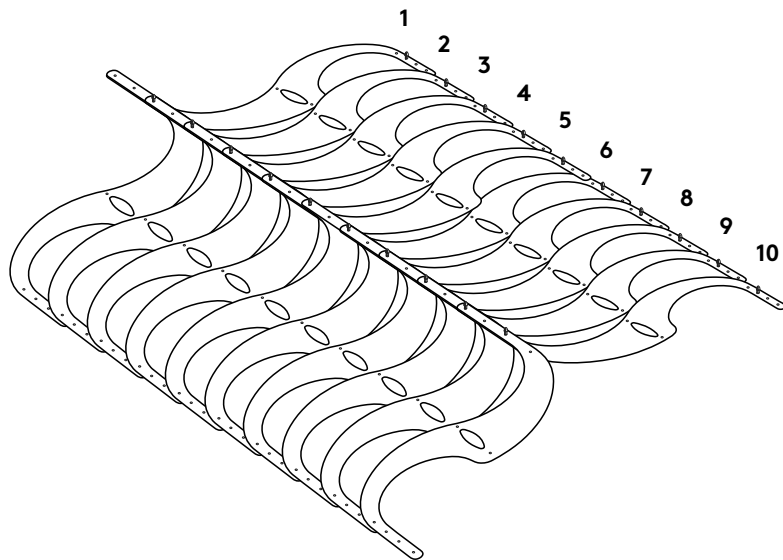

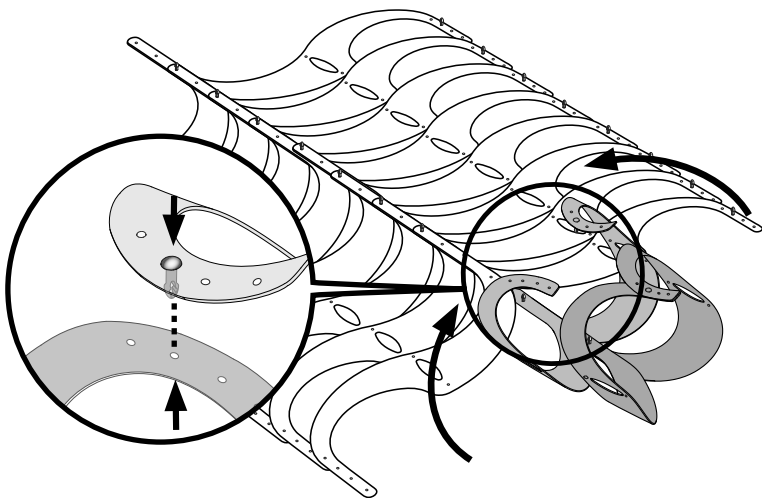
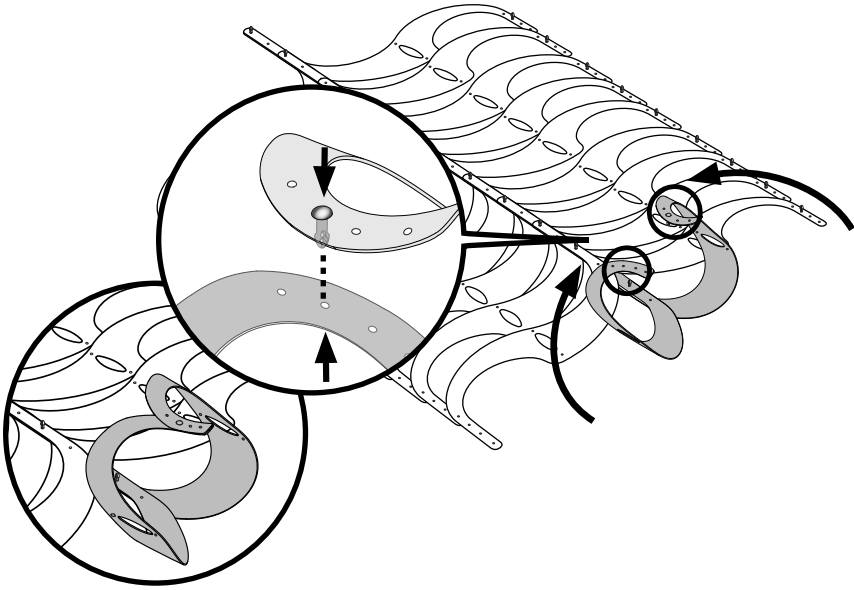

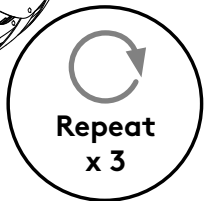
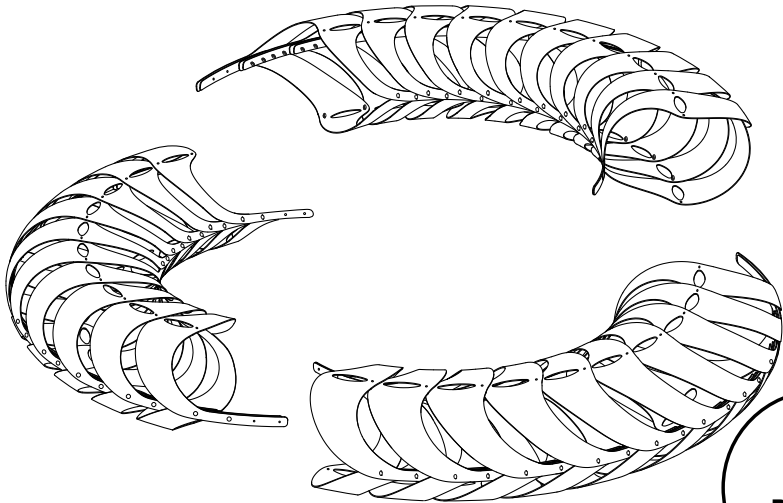
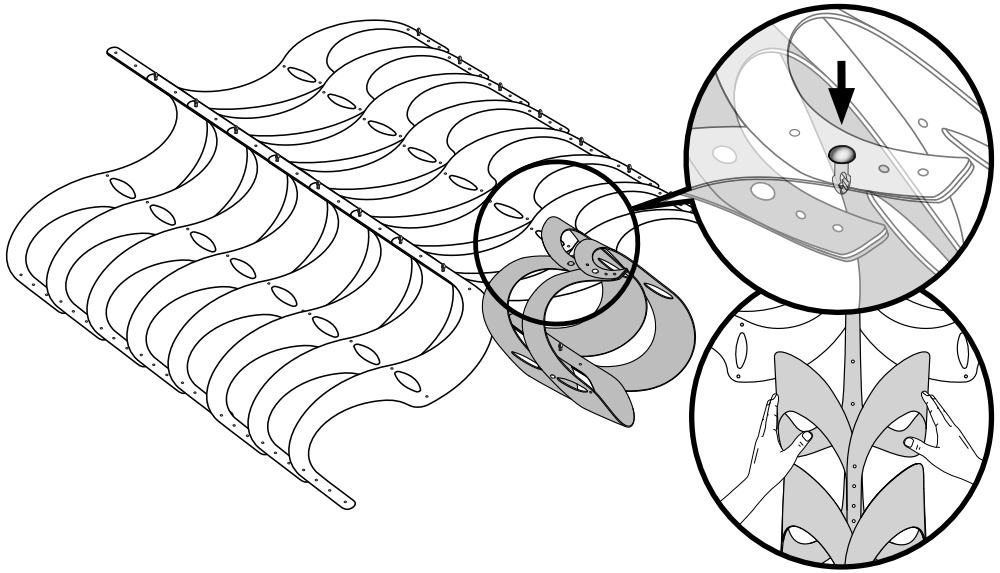

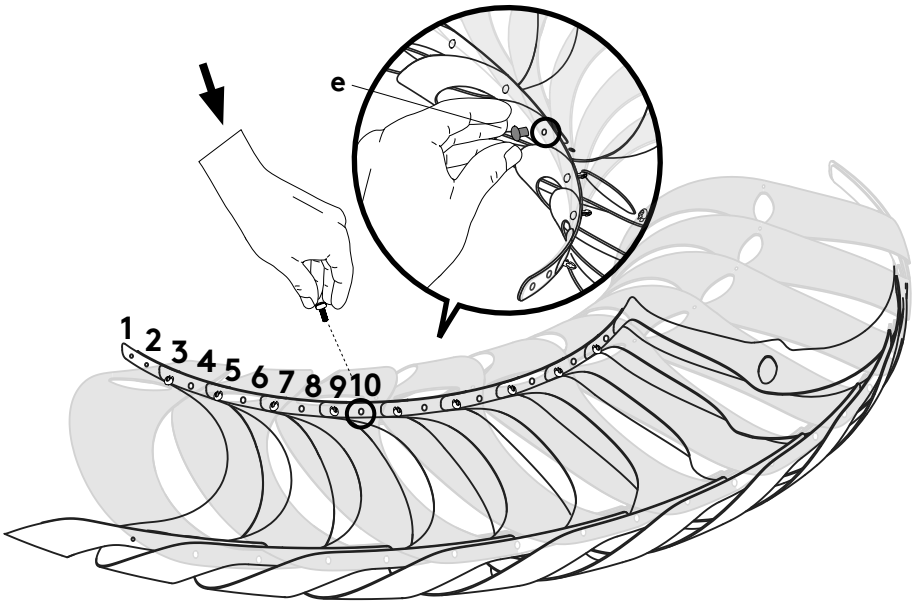
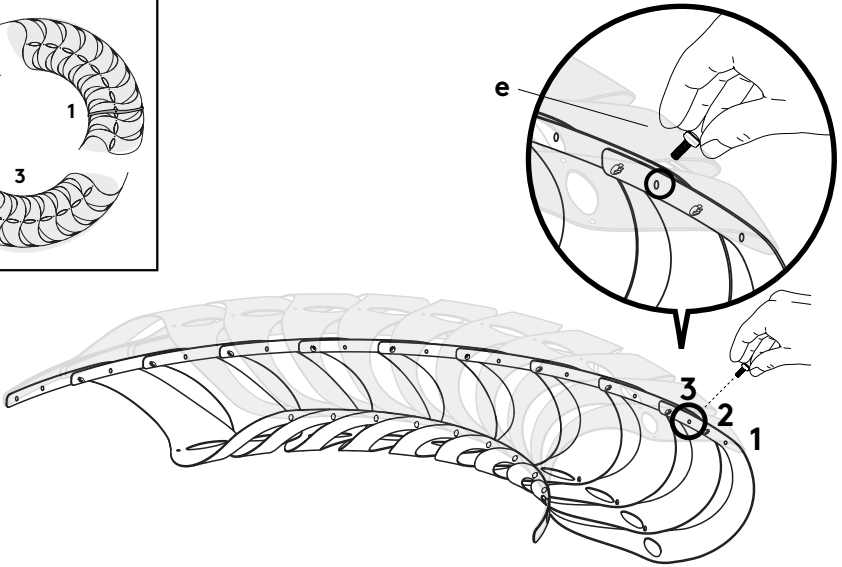
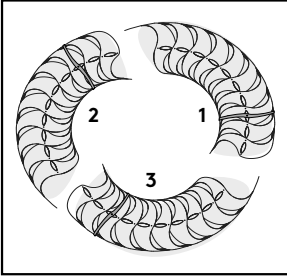

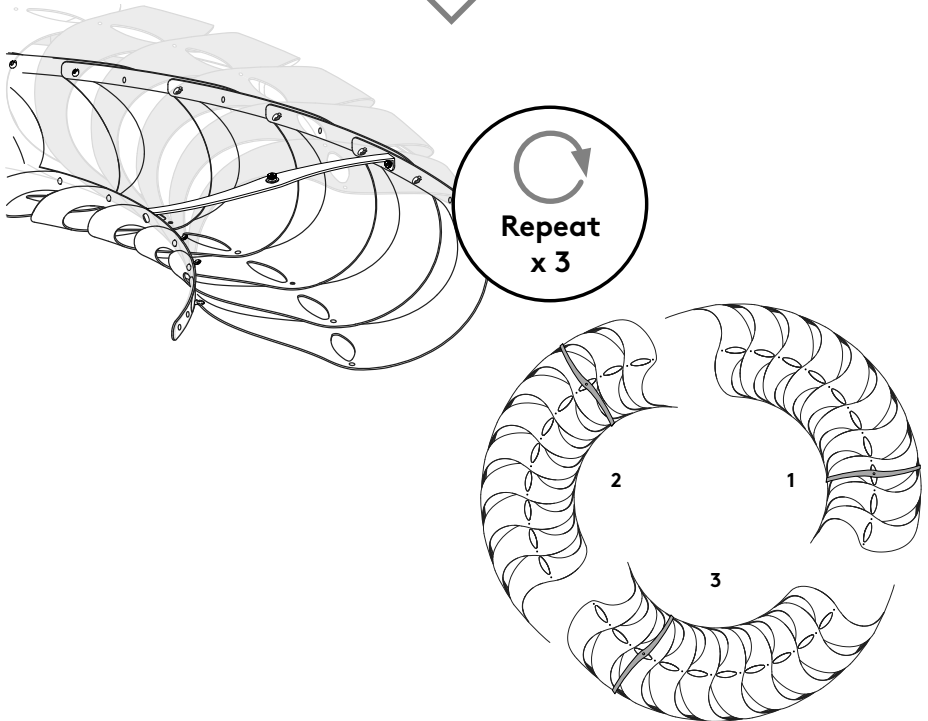
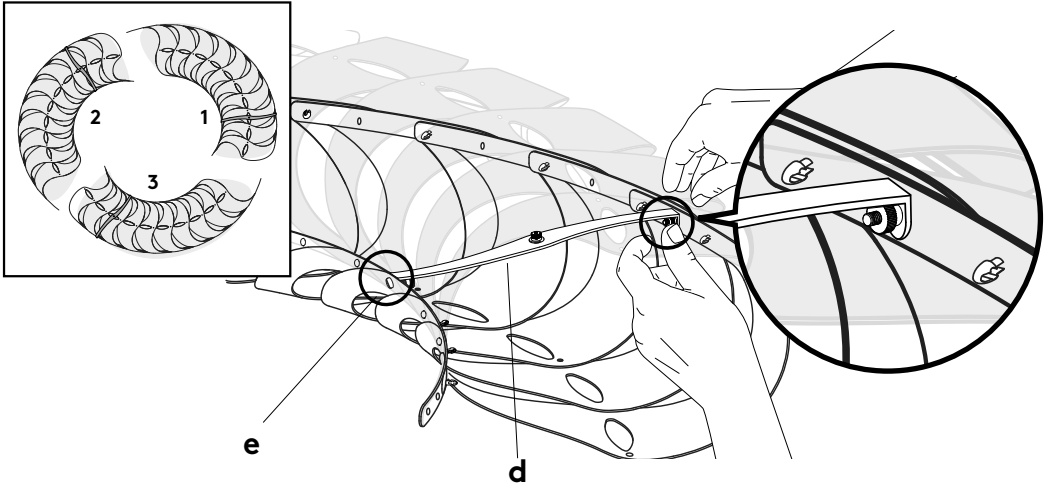

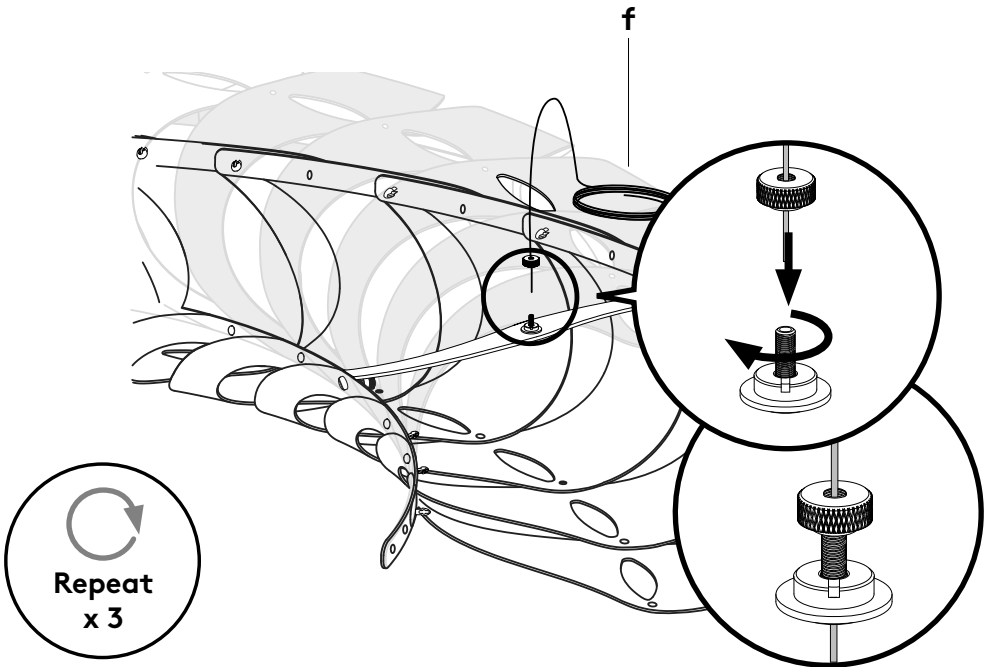
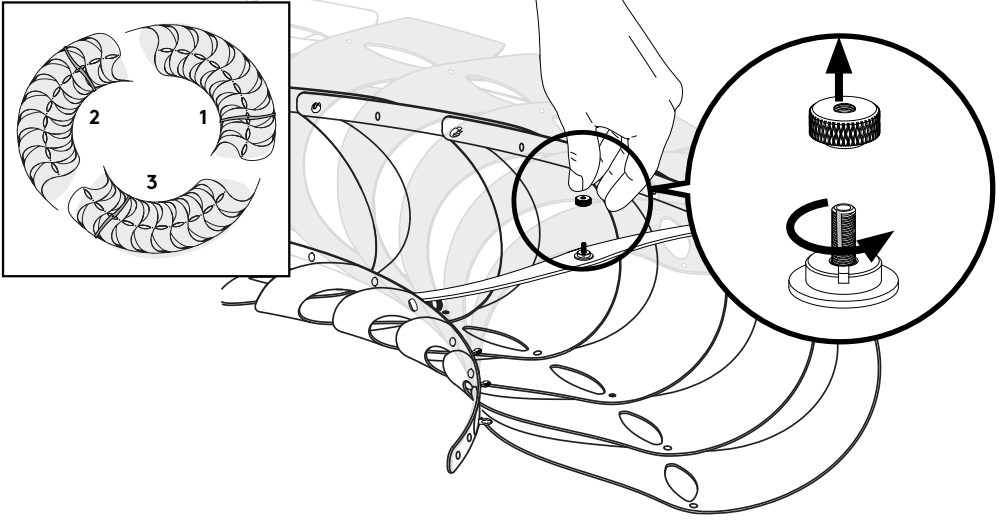

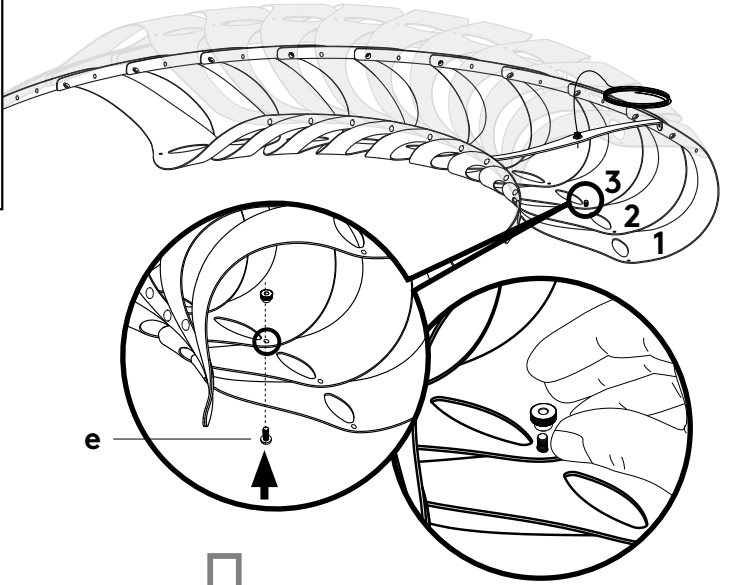
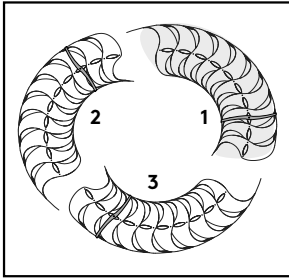

1

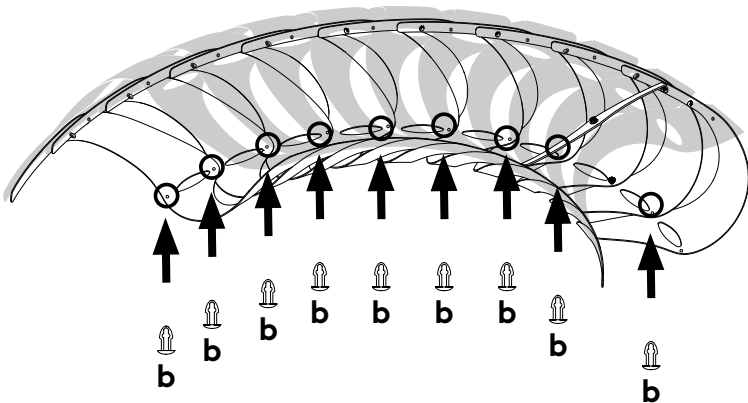

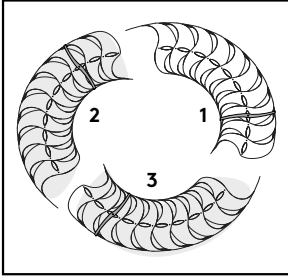

2

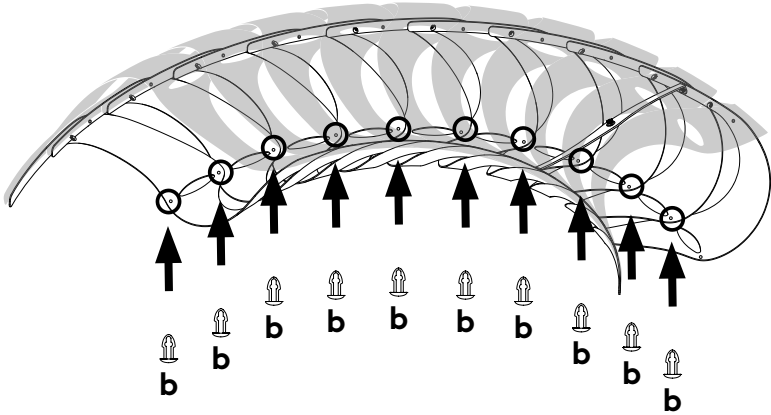

3

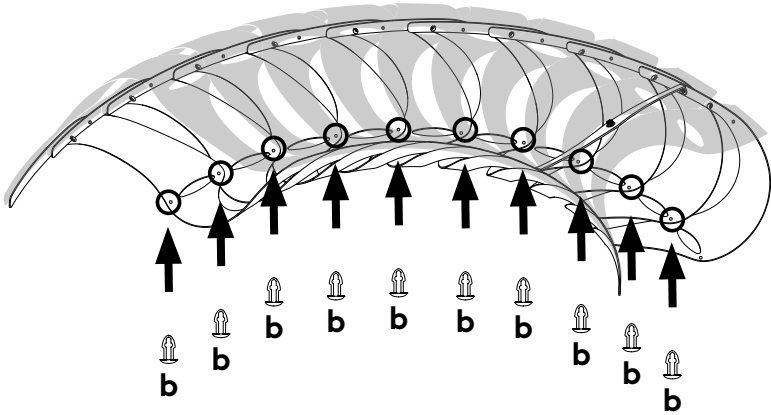

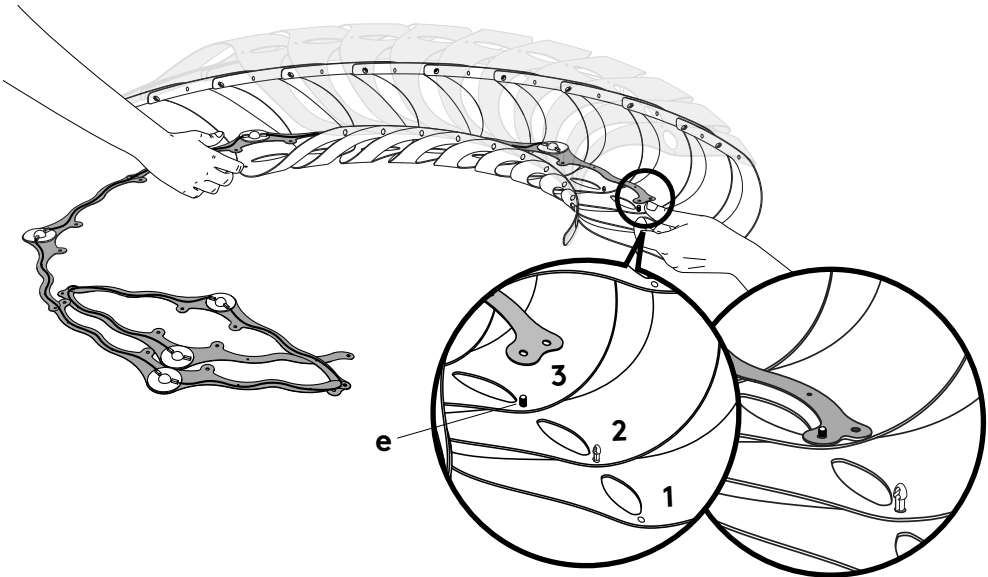
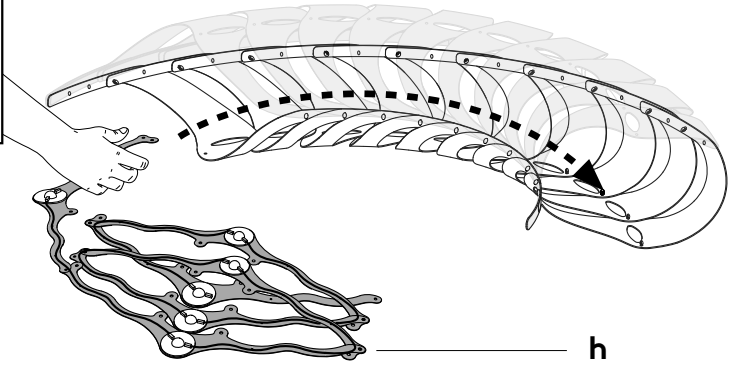
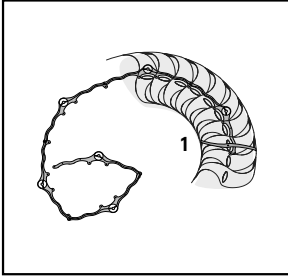

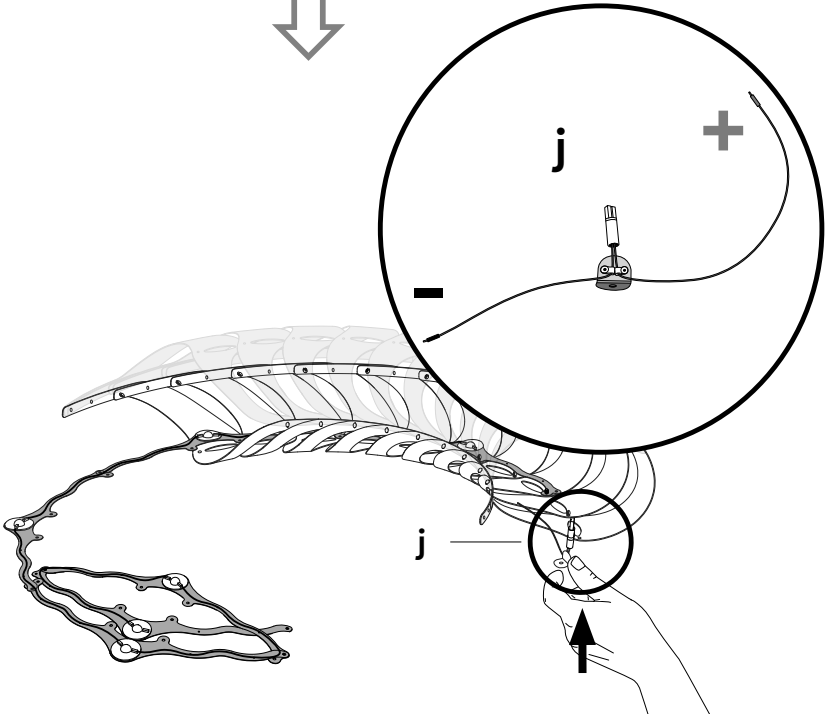
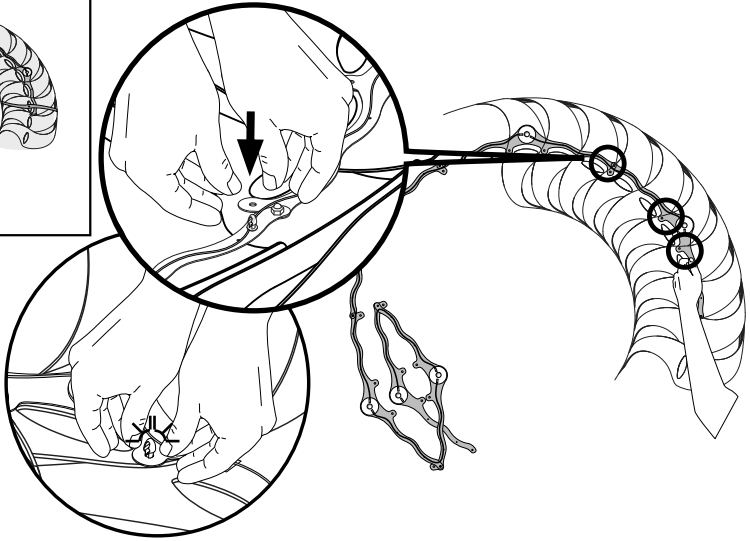
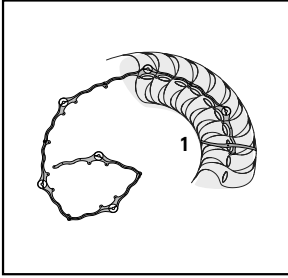

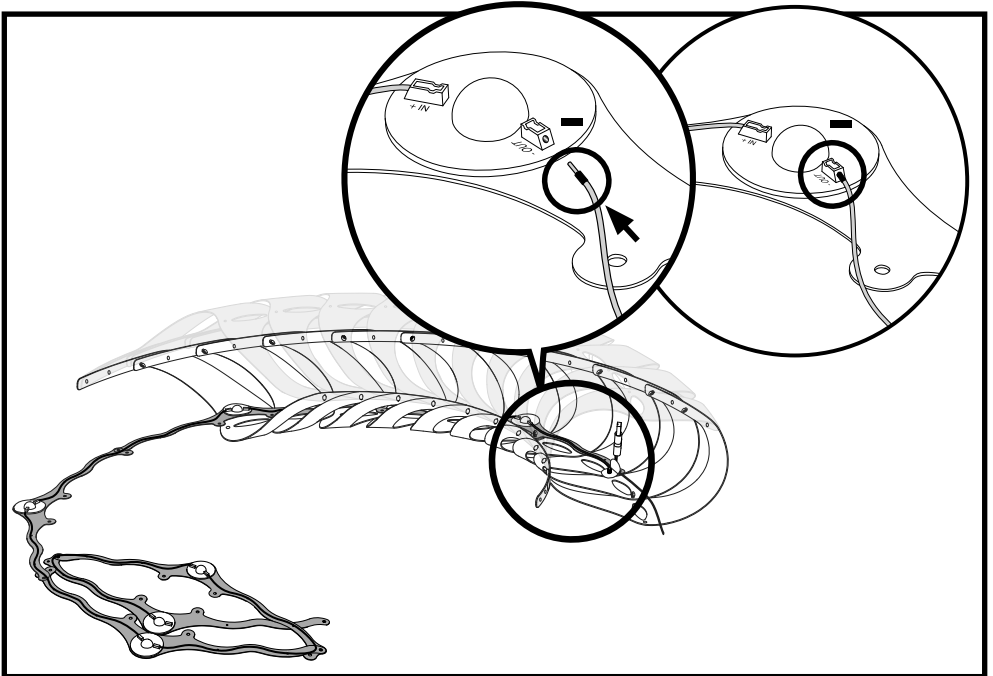
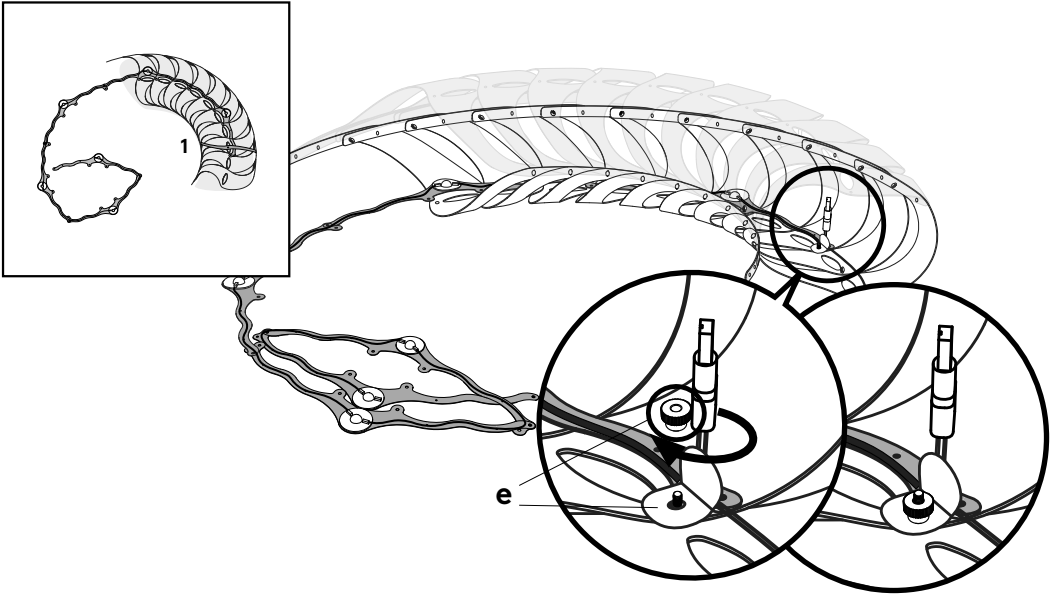

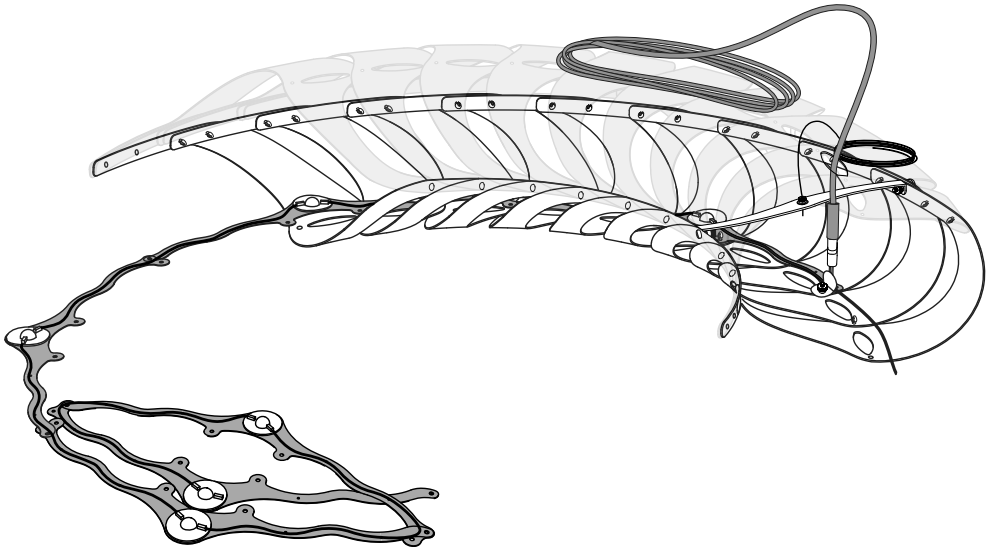
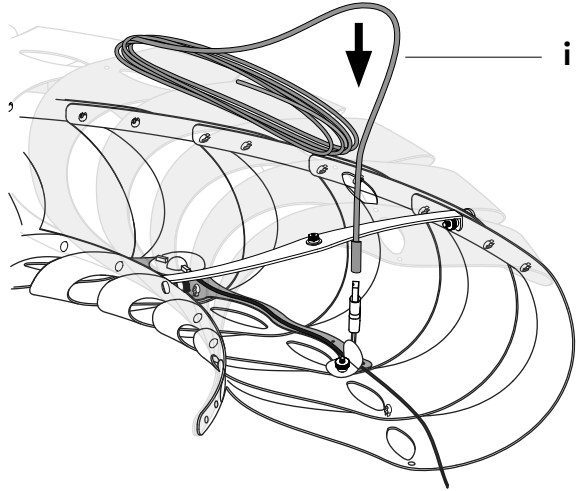
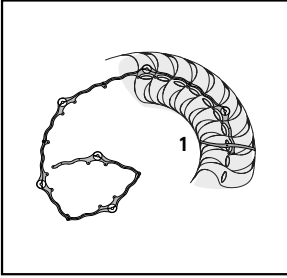

1

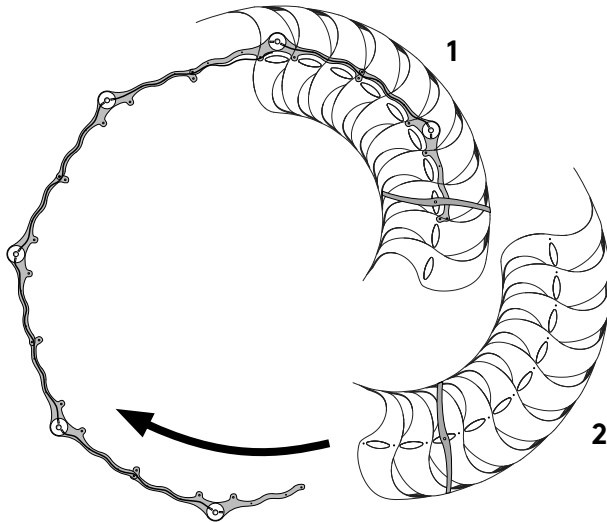
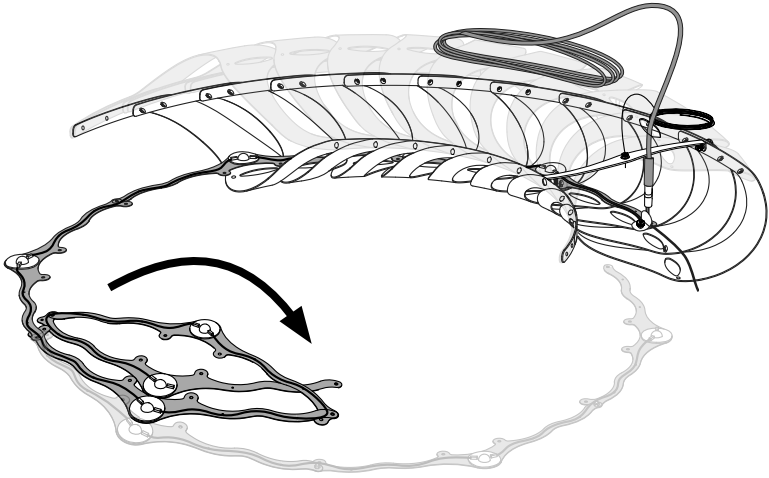

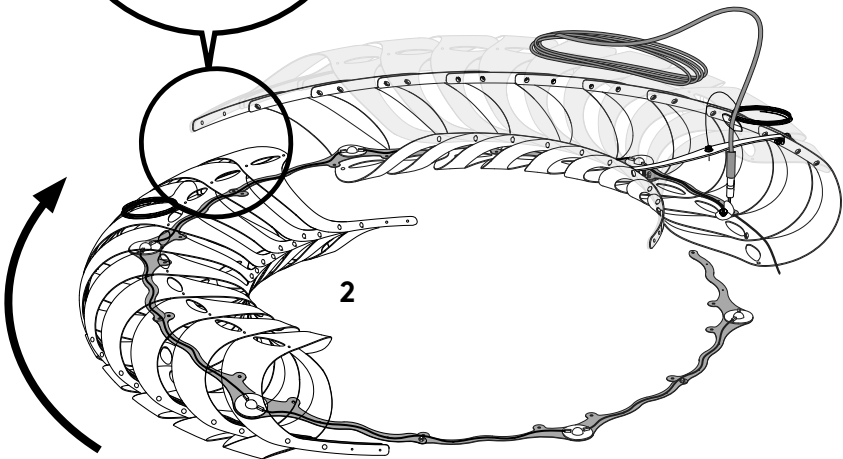
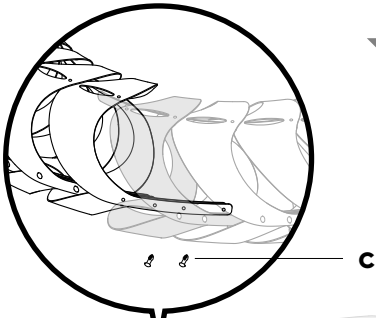
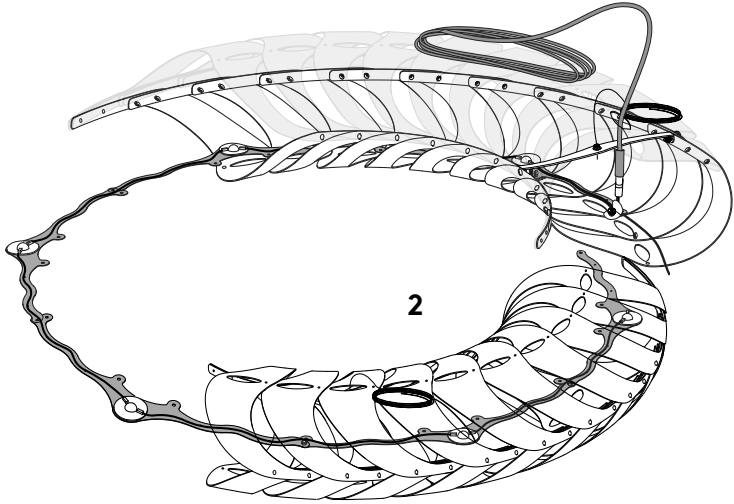

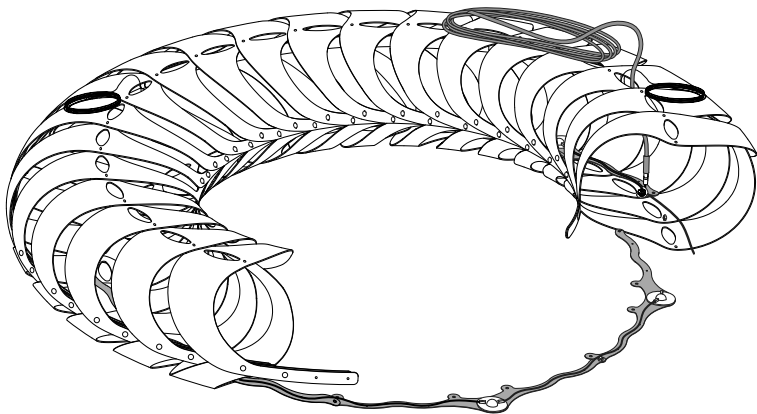
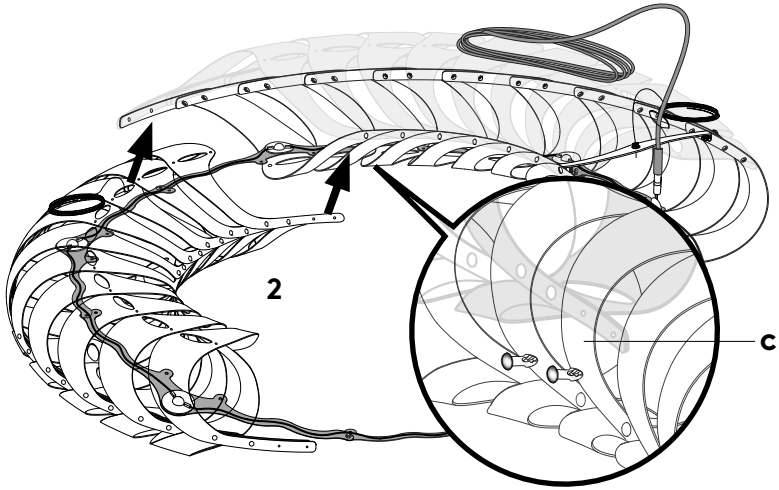

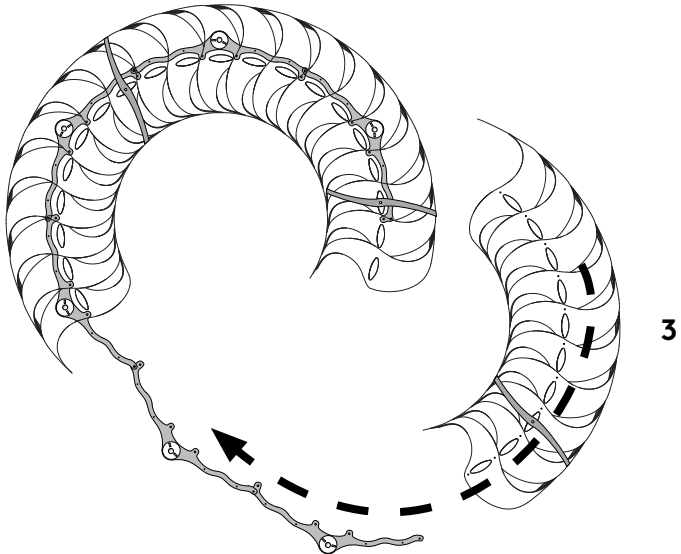
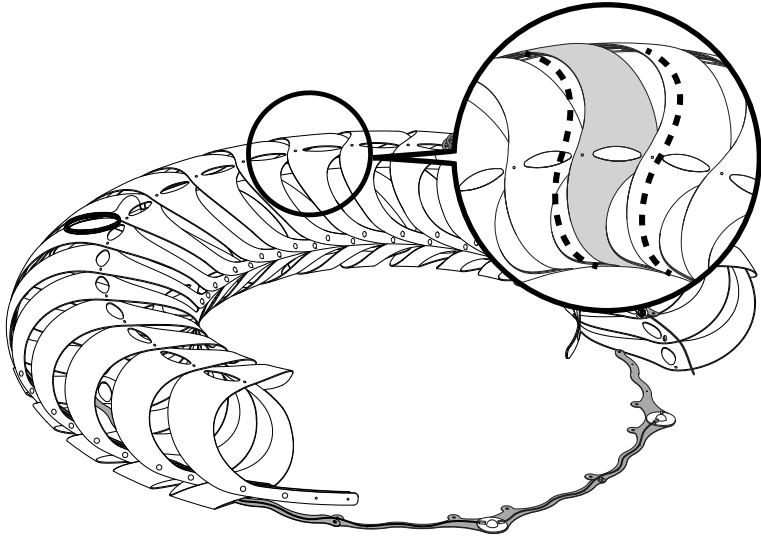

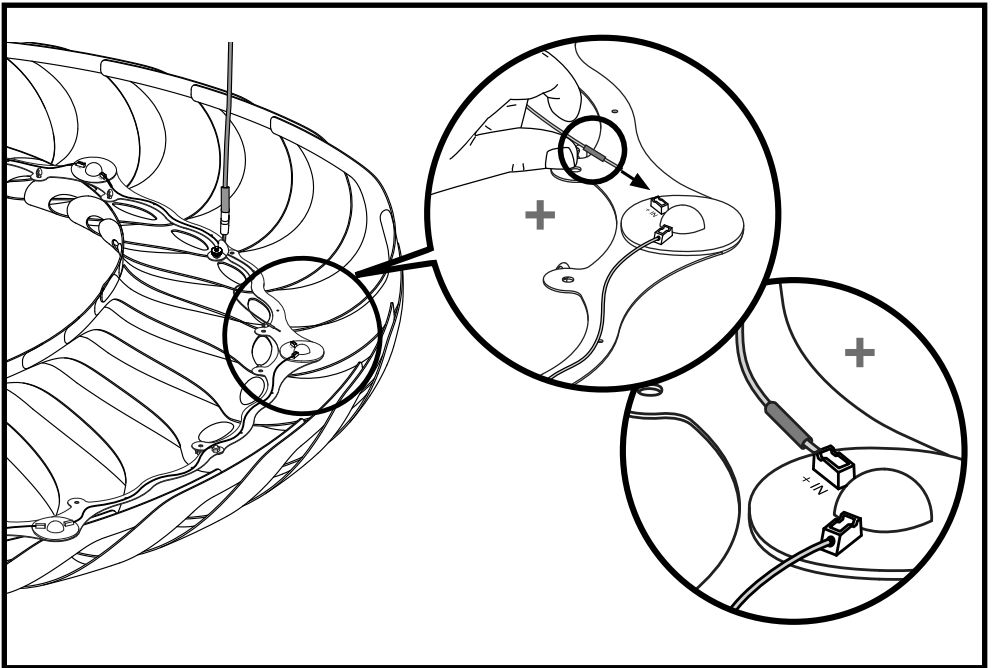
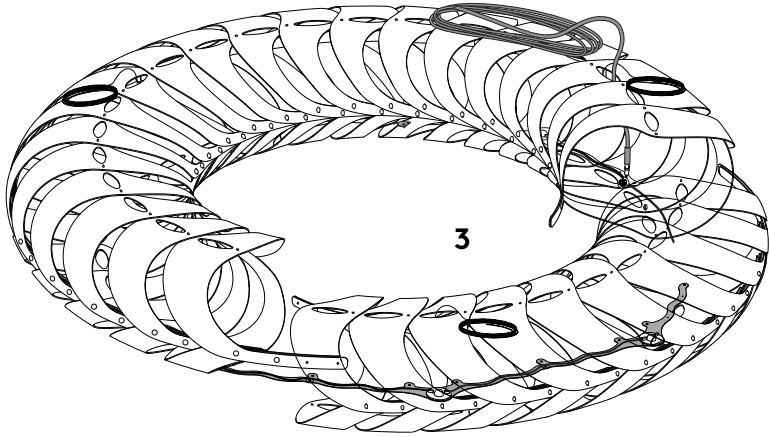

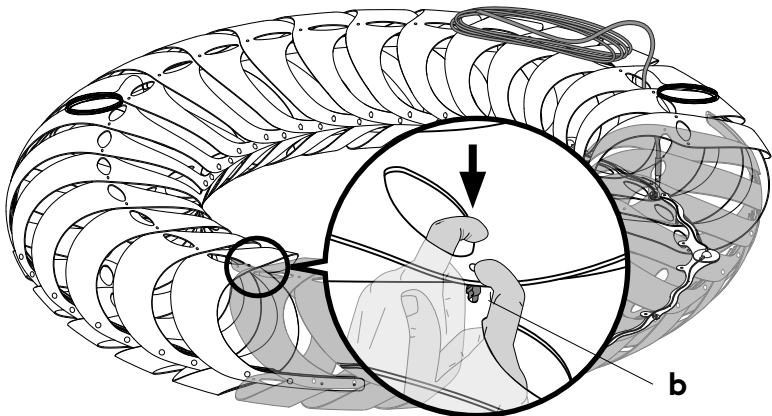
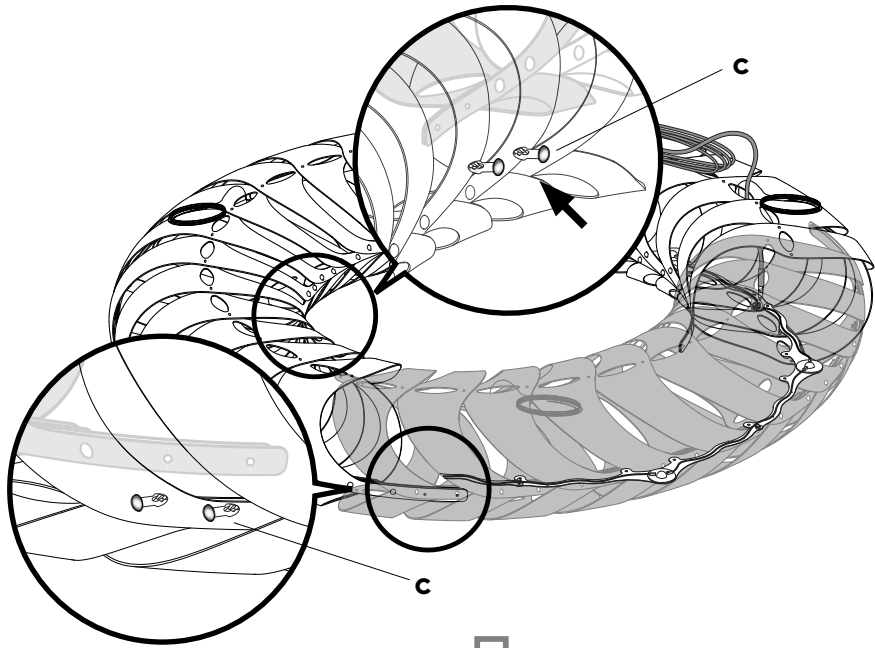

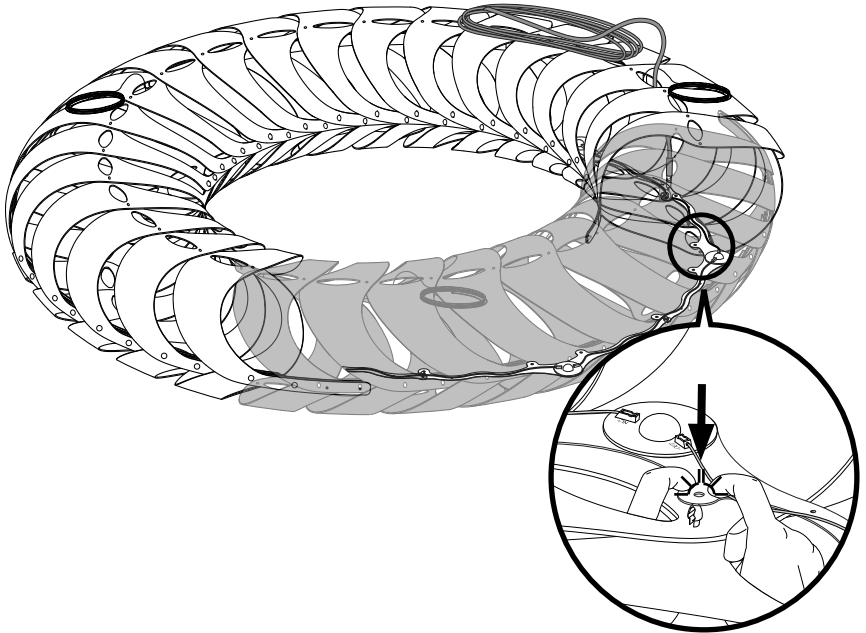
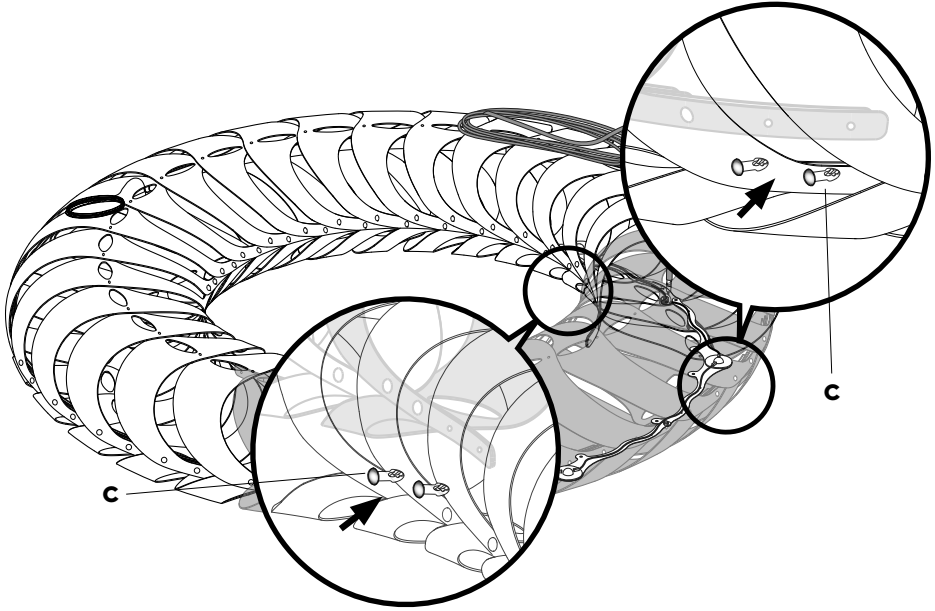

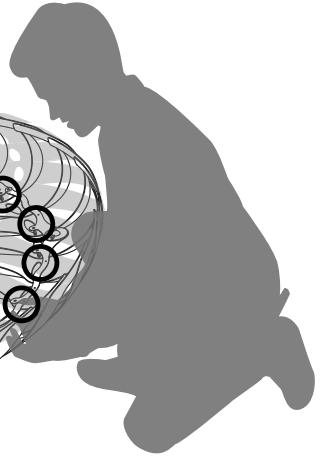
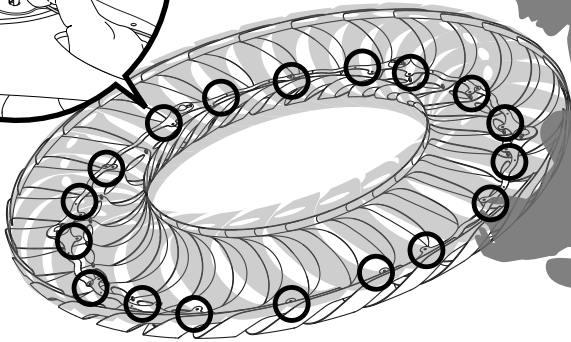
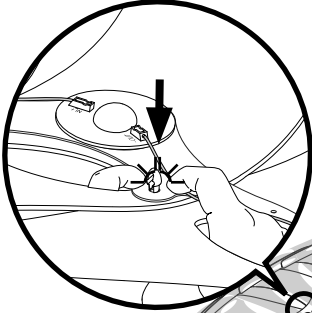
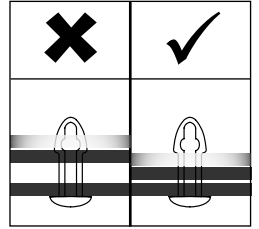
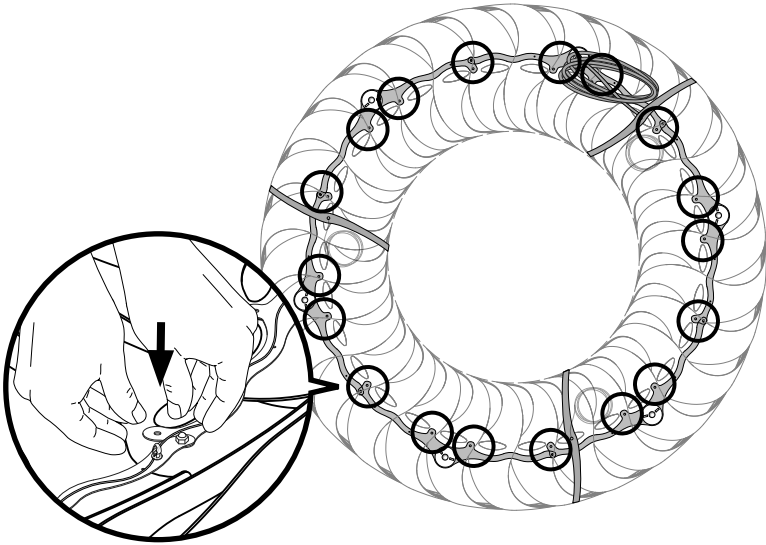

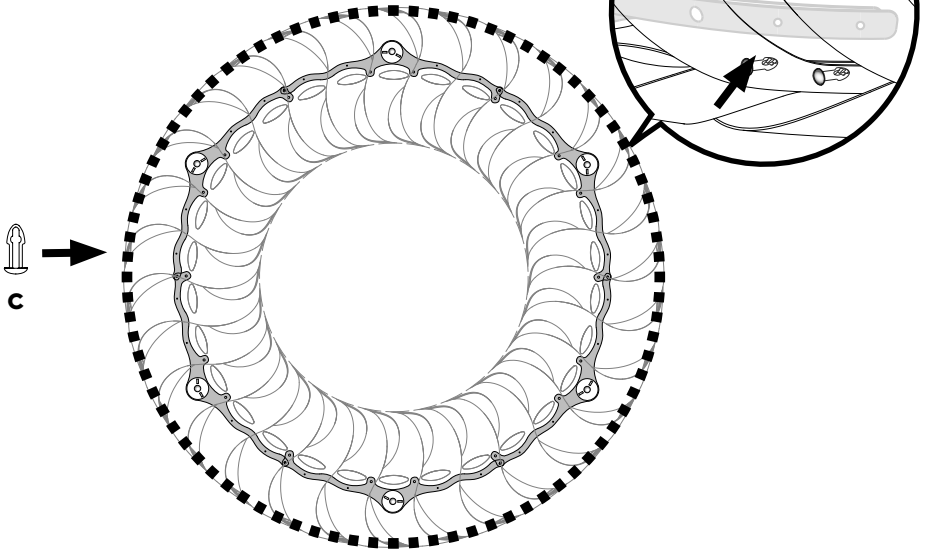
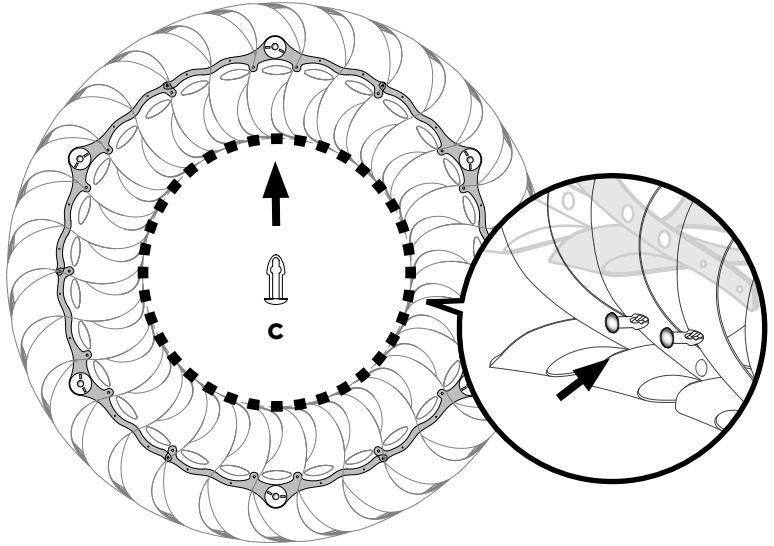

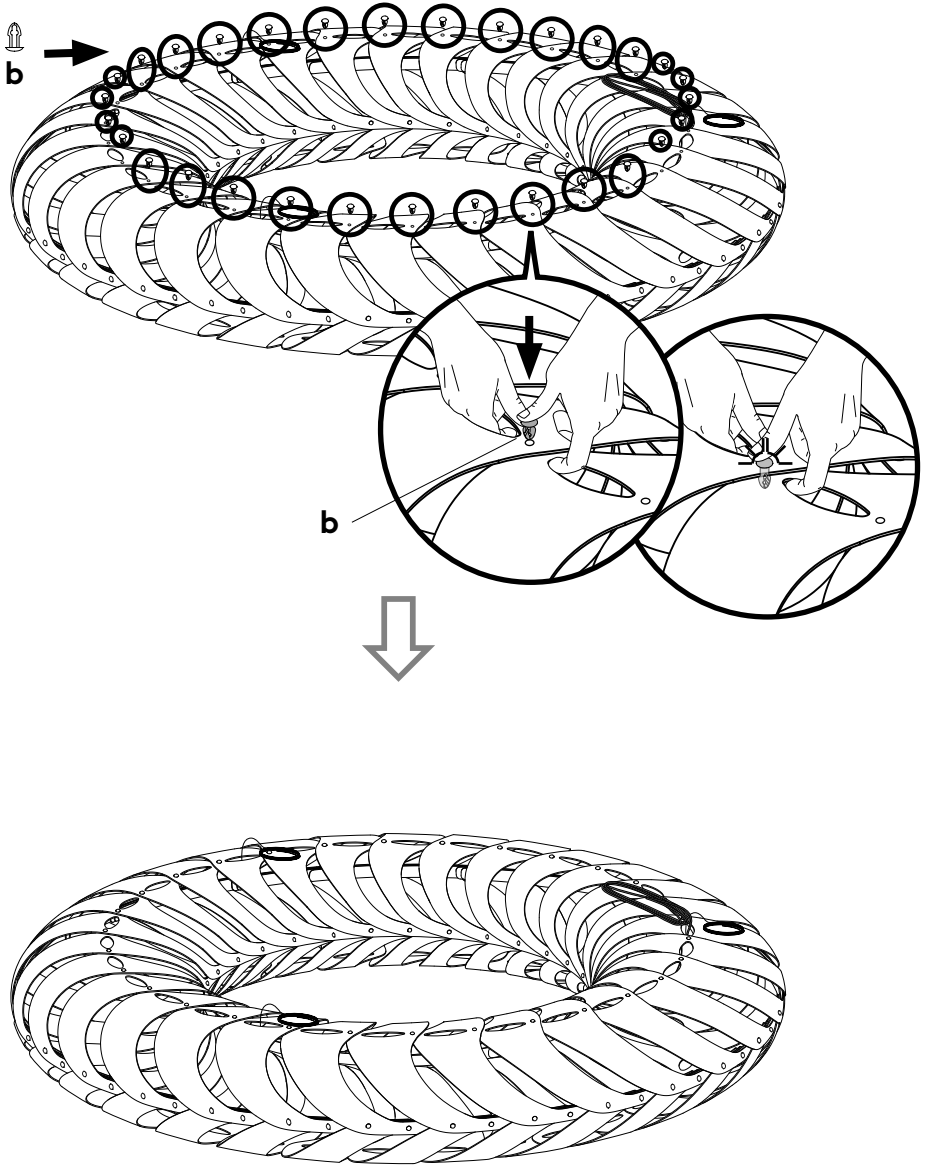

Installation / installazione / Installing / Instalacion

Limited Warranty / Garantie Limitee / Beschränkte Garantie / Garantía Limitada / Begrænset garanti / garanzia limi tata

Care Instructions / lamanutention / Pflegehinweise / Instrucciones de cuidado / Vedligeholdelse /manutenzzione

Installation / installazione / Installing / Instalacion

EN The light must be installed by a qualified Electrician in accordance with national wiring regulations - DO NOT attempt to install it yourself. TO BE INSTALLED IN DRY INDOOR AREAS ONLY.

FR Le luminaire doit être installé par un électricien qualifié, conformément aux réglementations nationales - Ne l'installez pas vous-même! Ce luminaire est conçu pour l'intérieur uniquement.

DE Das Licht muss von einem qualifizierten Elektriker in Übereinstimmung mit nationalen Installationsvorschriften installiert werden - Versuchen Sie NICHT, es selbst zu installieren. Die Lampe nur in trockenen Innenräumen installieren.

ES La luz debe ser instalado por un electricista cualificado de acuerdo con las regulaciones nacionales de cableado - NO intente instalar la lámpara usted mismo. A INSTALAR EN AREAS INTERIORES SECOS.

DK Lyset skal installeres af en autoriseret elektriker i overensstemmelse med nationale forskrifter for elektriske installationer - Forsøg IKKE at installere det selv. UDELUKKENDE TIL MONTERING I INDENDØRS.

IT La lampada deve essere installata da un elettricista qualificato in accordo con le vigenti normative nazionali - non provate a installarla da soli. DA INSTALLARE SOLO IN AREE INTERNE E ASCIUTTE.

Limited Warranty / Garantie Limitee / Beschränkte Garantie / Garantía Limitada / Begrænset garanti / garanzia limi tata

EN This light is warranted for three years from date of purchase for failure of parts, not including fair wear and tear. Please check now that all parts are present - we can only replace anything missing before assembly.

FR Ce luminaire est garanti pendant trois ans à compter de la date d'achat. La garantie exclue l'usure normale du luminaire (vieillesse naturelle du bois, couleur devenant fade...). Prenez soin de vérifier dès maintenant que toutes les pièces constituant la lampe sont au complet - nous ne remplaçons que les pièces manquantes avant assemblage.

DE Diese Lampe steht für drei Jahre ab dem Kaufdatum für den Defekt von Teilen unter Garantie. Darunter gilt nicht normale Abnutzung. Prüfen sie jetzt, dass alle Teile vorhanden sind - Fehlende oder defekte Teile können nur vor der Montage ersetzt werden.

ES Esta luz tiene una garantía de tres años contados desde la fecha de compra para el fracaso de las partes, sin incluir el uso y desgaste normal. Por favor, comprueba ahora que todas las partes están presentes - sólo podemos reemplazar partes faltantes antes del montaje.

DK Denne lampe er under garanti i tre år fra købsdatoen. Garantien gælder defekte dele, dog ikke grundet almindelig slid og ælde. Kontroller nu, at alle dele er til stede - vi erstatter kun manglende dele før samlesættet samles.

IT La garanzia è di tre anni dalla data di acquisto, è valida per i pezzi rotti o difettosi e non copre il normale deterioramento o i danni. Controllate sin da subito che tutte le parti siano presenti - sostituiamo eventuali pezzi mancanti solo prima dell'assemblaggio del prodotto.

Care Instructions / lamanutention / Pflegehinweise / Instrucciones de cuidado / Vedligeholdelse /manutenzzione

EN All wooden and/or polycarbonate lights are intended for use in dry interior conditions only, and can be cleaned with a soft cloth or duster when light is switched off.

FR Tous nos luminaires en bois et / ou polycarbonate sont destinés à un usage en intérieur uniquement. Ils peuvent être nettoyés avec un chiffon doux (éteindre la lampe avant de la nettoyer).

DE Alle Holz- und / oder Polycarbonat-leuchten sind nur für den Einsatz in trockenen Innenbereichen vorgesehen und wenn das Licht ausgeschaltet ist. Und kann mit einem weichen Tuch oder Staubtuch gereinigt werden wenn Licht ausgeschaltet ist.

ES Todas las luces de madera y / o de policarbonato están diseñadas para uso en zonas interiores secas solamente, y se puede limpiar con un paño suave o un plumero cuando se apaga la luz.

DK Alle træ-og/eller polycarbonat lamper er beregnet til brug indendørs, og kan rengøres med en blød klud eller duster når lyset slukkes.

IT Istruzioni per la cura e manutenzione: Tutte le lampade in legno e/o policarbonato sono progettate soltanto per uso interno con ambienti asciutti e possono essere pulite con un panno morbido inumidito in acqua tiepida e sapone, e può essere pulito con un panno morbido o spolverino quando la luce è spenta.

www.davidtrubridge.com

Follow us on

